

IS 345

DALI-2 APC - surface, rd.
EAN 4007841 033859
Article number 033859

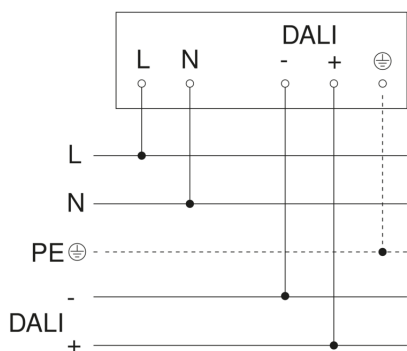

Master circuit diagram



Circuit diagram for interconnecting DALI-2 APC with DALI-2 IPD

